

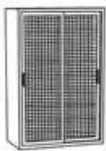







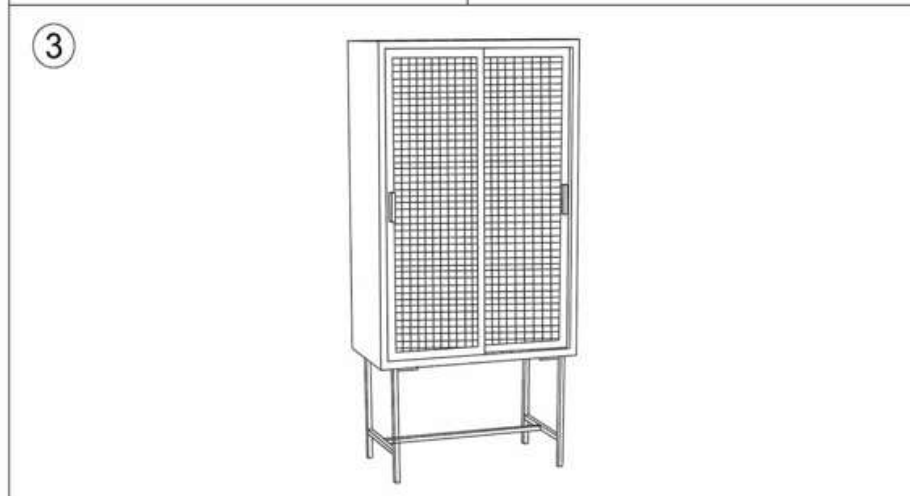
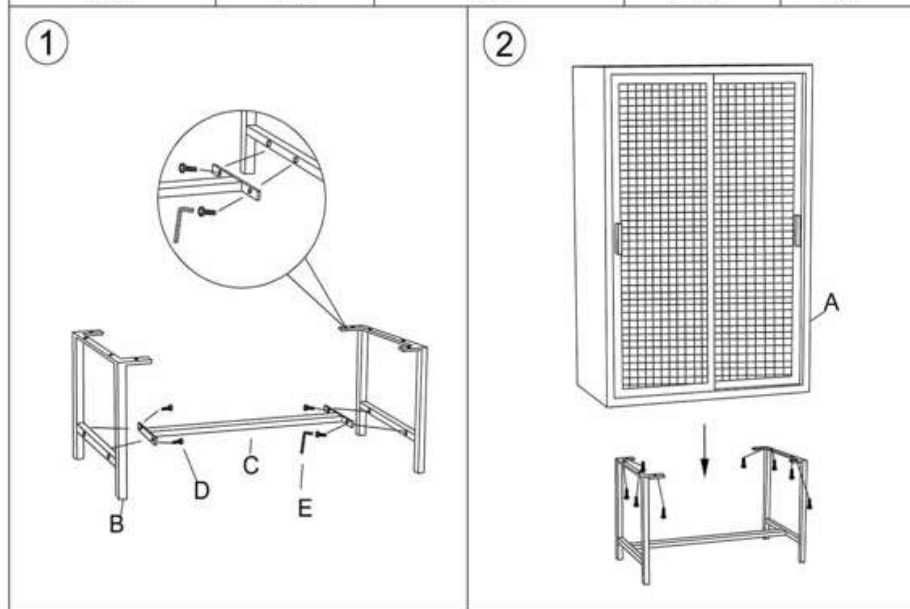

ART.NO.609.190

				
Ax1	Bx2	Cx1	Dx12	Ex1



ART.NO.609.190

				
Fx4	Gx2	Hx2	Ix2	Jx2

NL: Gebruik een schroevendraaier (PH2) voor montage
 DE: Benutzen Sie einen Schraubenzieher (PH2) für die Montage.
 FR: Utilisez un tournevis (PH2) pour le montage.

